

Driver LCO 40W 200–1050mA 64V pD+ NFC C PRE3
premium D4i NFC outdoor series

**Product description**

- _ Dimmable built-in constant current outdoor D4i LED driver
- _ Dimming range 1 to 100 % (min. 10 mA)
- _ For luminaires of protection class I and protection class II
- _ SELV for output voltage < 120 V DC
- _ Temperature protection as per EN 61347-2-13 C5e
- _ Output current adjustable between 200 – 1,050 mA via NFC, DALI or ready2mains Programmer
- _ Max. output power 40 W
- _ Up to 89.8 % efficiency
- _ Lowest power input on stand-by < 0.3 W
- _ Nominal lifetime of 100,000 h and 8 years guarantee (conditions at <https://www.tridonic.com/manufacturer-guarantee-conditions>)

Interfaces

- _ Near field communication (NFC)
- _ Powered DALI-2
- _ ready2mains (configuration via mains)
- _ U6Me2 (configuration of chronoSTEP via mains and ready2mains Programmer)
- _ Terminal blocks: 45° push terminals

Functions

- _ Adjustable output current in 1-mA-steps (NFC, DALI, ready2mains)
- _ Programmable chronoSTEP: times and levels (NFC, DALI, U6Me2)
- _ Enhanced constant light output function (eCLO)
- _ Protective features (overtemperature, short-circuit, overload, no-load, input voltage range, reduced surge amplification)
- _ Intelligent Temperature Guard (ITG)
- _ Intelligent Voltage Guard Plus (IVG+)
- _ Configurable external temperature management (ETM)
- _ Auxiliary 24 V, 3 W power supply
- _ DiiA/Zhaga connectivity extensions DT49, DT50, DT51, DT52

Benefits

- _ Flexible configuration via companionSUITE (NFC, DALI, ready2mains™) or U6Me2 programmer
- _ Operating window for maximum compatibility
- _ Best energy savings due to low stand-by losses and high efficiency
- _ In-field programming possible after installation with NFC interface and ready2mains
- _ High overvoltage protection: up to 10 kV asymmetric (protection class I and II)

Typical applications

- _ Road, street and industry

Website

<http://www.tridonic.com/87500830>



Spotlights



Downlights



Linear



Area



Floor | Wall



Free-standing



Street



Decorative



High bay

Driver LCO 40W 200–1050mA 64V pD+ NFC C PRE3

premium D4i NFC outdoor series

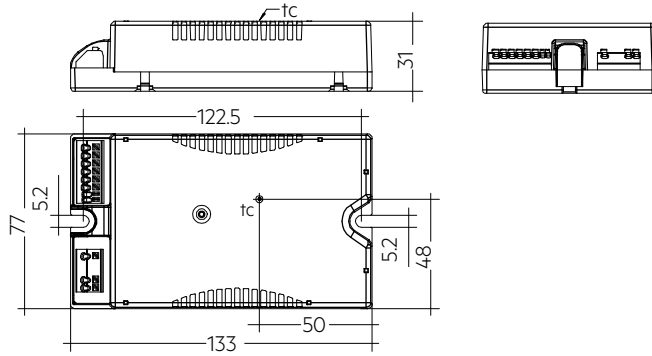
**Ordering data**

Type	Article number	Packaging, carton	Packaging, pallet	Weight per pc.
LCO 40/200-1050/64 pD+ NF C PRE3	87500830	20 pc(s).	240 pc(s).	0.294 kg
LCO 40/200-1050/64 pD+ NF C PRE3	28004662	20 pc(s).	1,120 pc(s).	0.294 kg

Technical data

Rated supply voltage	220 – 240 V
AC voltage range	198 – 264 V
DC voltage range	176 – 280 V
Mains frequency	0 / 50 / 60 Hz
Overvoltage protection	320 V AC, 48 h
Typ. rated current (at 230 V, 50 Hz, full load) ^{①②}	270 mA
Typ. current (220 V, 0 Hz, full load, 15 % dimming level) ^②	42 mA
Leakage current (at 230 V, 50 Hz, full load) ^{①②}	< 500 µA
Touch current (equipotential connected) ^③	440 µA
Max. input power	53 W
Typ. efficiency (at 230 V, 50 Hz, full load) ^{②④}	89.8 %
λ (at 230 V, 50 Hz, full load) ^①	0.97
Typ. power consumption on stand-by ^⑤	< 0.3 W
In-rush current (peak / duration)	20.3 A / 346 µs
THD (at 230 V, 50 Hz, full load) ^①	< 8 %
Starting time (AC mode)	< 750 ms
Starting time (DC mode)	< 650 ms
Switchover time (AC/DC)	< 300 ms
Turn off time (at 230 V, 50 Hz, full load)	< 500 ms
Output current tolerance ^{①⑥}	± 3 %
Max. output current peak (non-repetitive)	≤ output current + 15 %
Output LF current ripple (< 120 Hz)	± 3.3 %
Output P_ST_LM (at full load)	≤ 1
Output SVM (at full load)	≤ 0.4
Max. output voltage (U-OUT)	90 V
Max. output voltage (HV)	90 V
Max. output voltage (LV)	50 V
Dimming range	1 – 100 %
Mains surge capability (between L - N) ^⑦	6 kV / 3 kA
Mains surge capability (between L/N - PE)	10 kV
Burst protection	6 kV
DALI burst capability	1 kV
Surge voltage at output side (against PE)	< 1 kV
Type of protection	IP20
Lifetime	up to 100,000 h
Guarantee (conditions at www.tridonic.com)	8 Year(s)
Dimensions L x W x H	133 x 77 x 31 mm

Approval marks**Standards**

EN 55015, EN 61000-3-2, EN 61000-3-3, EN 61000-4-4, EN 61000-4-5, EN 61347-1, EN 61347-2-13, EN 62384, EN 61547, EN 62386-101, EN 62386-102, EN 62386-207 (DALI-2), according to EN 50172, according to EN 60598-2-22

Specific technical data

Type	Output current [®]	Min. output voltage	Max. output voltage	Max. output power	Typ. power consumption (at 230 V, 50 Hz, full load)	Typ. current consumption (at 230 V, 50 Hz, full load)	tc point max.	Ambient temperature ta
High voltage output (HV)								
LCO 40/200-1050/64 pD+ NF C PRE3	200 mA	32.0 V	64.0 V	12.8 W	15.8 W	73 mA	90 °C	-40 ... +70 °C
LCO 40/200-1050/64 pD+ NF C PRE3	250 mA	30.0 V	64.0 V	16.0 W	19.1 W	87 mA	90 °C	-40 ... +70 °C
LCO 40/200-1050/64 pD+ NF C PRE3	300 mA	30.0 V	64.0 V	19.2 W	22.5 W	101 mA	90 °C	-40 ... +70 °C
LCO 40/200-1050/64 pD+ NF C PRE3	350 mA	30.0 V	64.0 V	22.4 W	25.8 W	115 mA	90 °C	-40 ... +70 °C
LCO 40/200-1050/64 pD+ NF C PRE3	400 mA	30.0 V	64.0 V	25.6 W	29.2 W	130 mA	90 °C	-40 ... +70 °C
LCO 40/200-1050/64 pD+ NF C PRE3	450 mA	30.0 V	64.0 V	28.8 W	32.6 W	144 mA	90 °C	-40 ... +70 °C
LCO 40/200-1050/64 pD+ NF C PRE3	500 mA	30.0 V	64.0 V	32.0 W	36.1 W	159 mA	90 °C	-40 ... +70 °C
LCO 40/200-1050/64 pD+ NF C PRE3	550 mA	30.0 V	64.0 V	35.2 W	39.5 W	174 mA	90 °C	-40 ... +70 °C
LCO 40/200-1050/64 pD+ NF C PRE3	600 mA	30.0 V	64.0 V	38.4 W	42.9 W	189 mA	90 °C	-40 ... +70 °C
LCO 40/200-1050/64 pD+ NF C PRE3	650 mA	30.0 V	61.5 V	40.0 W	44.7 W	196 mA	90 °C	-40 ... +70 °C
LCO 40/200-1050/64 pD+ NF C PRE3	700 mA	30.0 V	57.1 V	40.0 W	44.6 W	196 mA	90 °C	-40 ... +70 °C
LCO 40/200-1050/64 pD+ NF C PRE3	750 mA	30.0 V	53.3 V	40.0 W	44.7 W	196 mA	90 °C	-40 ... +70 °C
LCO 40/200-1050/64 pD+ NF C PRE3	800 mA	30.0 V	50.0 V	40.0 W	44.8 W	197 mA	90 °C	-40 ... +70 °C
LCO 40/200-1050/64 pD+ NF C PRE3	850 mA	30.0 V	47.1 V	40.0 W	44.7 W	196 mA	90 °C	-40 ... +70 °C
LCO 40/200-1050/64 pD+ NF C PRE3	900 mA	30.0 V	44.4 V	40.0 W	44.4 W	195 mA	90 °C	-40 ... +70 °C
LCO 40/200-1050/64 pD+ NF C PRE3	950 mA	30.0 V	42.1 V	40.0 W	44.7 W	196 mA	90 °C	-40 ... +70 °C
LCO 40/200-1050/64 pD+ NF C PRE3	1,000 mA	30.0 V	40.0 V	40.0 W	44.8 W	197 mA	90 °C	-40 ... +70 °C
LCO 40/200-1050/64 pD+ NF C PRE3	1,050 mA	30.0 V	38.1 V	40.0 W	44.7 W	196 mA	90 °C	-40 ... +70 °C
LCO 40/200-1050/64 pD+ NF C PRE3	200 mA	32.0 V	64.0 V	12.8 W	15.8 W	73 mA	90 °C	-40 ... +70 °C
LCO 40/200-1050/64 pD+ NF C PRE3	250 mA	30.0 V	64.0 V	16.0 W	19.1 W	87 mA	90 °C	-40 ... +70 °C
LCO 40/200-1050/64 pD+ NF C PRE3	300 mA	30.0 V	64.0 V	19.2 W	22.5 W	101 mA	90 °C	-40 ... +70 °C
LCO 40/200-1050/64 pD+ NF C PRE3	350 mA	30.0 V	64.0 V	22.4 W	25.8 W	115 mA	90 °C	-40 ... +70 °C
LCO 40/200-1050/64 pD+ NF C PRE3	400 mA	30.0 V	64.0 V	25.6 W	29.2 W	130 mA	90 °C	-40 ... +70 °C
LCO 40/200-1050/64 pD+ NF C PRE3	450 mA	30.0 V	64.0 V	28.8 W	32.6 W	144 mA	90 °C	-40 ... +70 °C
LCO 40/200-1050/64 pD+ NF C PRE3	500 mA	30.0 V	64.0 V	32.0 W	36.1 W	159 mA	90 °C	-40 ... +70 °C
LCO 40/200-1050/64 pD+ NF C PRE3	550 mA	30.0 V	64.0 V	35.2 W	39.5 W	174 mA	90 °C	-40 ... +70 °C
LCO 40/200-1050/64 pD+ NF C PRE3	600 mA	30.0 V	64.0 V	38.4 W	42.9 W	189 mA	90 °C	-40 ... +70 °C
LCO 40/200-1050/64 pD+ NF C PRE3	650 mA	30.0 V	61.5 V	40.0 W	44.7 W	196 mA	90 °C	-40 ... +70 °C
LCO 40/200-1050/64 pD+ NF C PRE3	700 mA	30.0 V	57.1 V	40.0 W	44.6 W	196 mA	90 °C	-40 ... +70 °C
LCO 40/200-1050/64 pD+ NF C PRE3	750 mA	30.0 V	53.3 V	40.0 W	44.7 W	196 mA	90 °C	-40 ... +70 °C
LCO 40/200-1050/64 pD+ NF C PRE3	800 mA	30.0 V	50.0 V	40.0 W	44.8 W	197 mA	90 °C	-40 ... +70 °C
LCO 40/200-1050/64 pD+ NF C PRE3	850 mA	30.0 V	47.1 V	40.0 W	44.7 W	196 mA	90 °C	-40 ... +70 °C
LCO 40/200-1050/64 pD+ NF C PRE3	900 mA	30.0 V	44.4 V	40.0 W	44.4 W	195 mA	90 °C	-40 ... +70 °C
LCO 40/200-1050/64 pD+ NF C PRE3	950 mA	30.0 V	42.1 V	40.0 W	44.7 W	196 mA	90 °C	-40 ... +70 °C
LCO 40/200-1050/64 pD+ NF C PRE3	1,000 mA	30.0 V	40.0 V	40.0 W	44.8 W	197 mA	90 °C	-40 ... +70 °C
LCO 40/200-1050/64 pD+ NF C PRE3	1,050 mA	30.0 V	38.1 V	40.0 W	44.7 W	196 mA	90 °C	-40 ... +70 °C
Low voltage output (LV)								
LCO 40/200-1050/64 pD+ NF C PRE3	200 mA	32.0 V	38.0 V	7.6 W	10.8 W	53 mA	90 °C	-40 ... +70 °C
LCO 40/200-1050/64 pD+ NF C PRE3	250 mA	25.6 V	38.0 V	9.5 W	12.8 W	61 mA	90 °C	-40 ... +70 °C
LCO 40/200-1050/64 pD+ NF C PRE3	300 mA	21.3 V	38.0 V	11.4 W	14.8 W	69 mA	90 °C	-40 ... +70 °C
LCO 40/200-1050/64 pD+ NF C PRE3	350 mA	18.3 V	38.0 V	13.3 W	16.8 W	77 mA	90 °C	-40 ... +70 °C
LCO 40/200-1050/64 pD+ NF C PRE3	400 mA	18.0 V	38.0 V	15.2 W	18.8 W	86 mA	90 °C	-40 ... +70 °C
LCO 40/200-1050/64 pD+ NF C PRE3	450 mA	18.0 V	38.0 V	17.1 W	20.8 W	94 mA	85 °C	-40 ... +65 °C
LCO 40/200-1050/64 pD+ NF C PRE3	500 mA	18.0 V	38.0 V	19.0 W	23.0 W	103 mA	85 °C	-40 ... +65 °C
LCO 40/200-1050/64 pD+ NF C PRE3	550 mA	18.0 V	38.0 V	20.9 W	24.9 W	111 mA	85 °C	-40 ... +65 °C
LCO 40/200-1050/64 pD+ NF C PRE3	600 mA	18.0 V	38.0 V	22.8 W	26.9 W	120 mA	85 °C	-40 ... +65 °C
LCO 40/200-1050/64 pD+ NF C PRE3	650 mA	18.0 V	38.0 V	24.7 W	28.9 W	129 mA	85 °C	-40 ... +65 °C
LCO 40/200-1050/64 pD+ NF C PRE3	700 mA	18.0 V	38.0 V	26.6 W	31.0 W	137 mA	85 °C	-40 ... +65 °C
LCO 40/200-1050/64 pD+ NF C PRE3	750 mA	18.0 V	38.0 V	28.5 W	33.1 W	147 mA	85 °C	-40 ... +65 °C
LCO 40/200-1050/64 pD+ NF C PRE3	800 mA	18.0 V	38.0 V	30.4 W	35.1 W	155 mA	85 °C	-40 ... +65 °C
LCO 40/200-1050/64 pD+ NF C PRE3	850 mA	18.0 V	38.0 V	32.3 W	37.3 W	165 mA	90 °C	-40 ... +65 °C
LCO 40/200-1050/64 pD+ NF C PRE3	900 mA	18.0 V	38.0 V	34.2 W	39.4 W	174 mA	90 °C	-40 ... +65 °C
LCO 40/200-1050/64 pD+ NF C PRE3	950 mA	18.0 V	38.0 V	36.1 W	41.5 W	183 mA	90 °C	-40 ... +65 °C
LCO 40/200-1050/64 pD+ NF C PRE3	1,000 mA	18.0 V	38.0 V	38.0 W	43.5 W	191 mA	90 °C	-40 ... +65 °C
LCO 40/200-1050/64 pD+ NF C PRE3	1,050 mA	18.0 V	38.0 V	39.9 W	45.7 W	201 mA	90 °C	-40 ... +65 °C
LCO 40/200-1050/64 pD+ NF C PRE3	200 mA	32.0 V	38.0 V	7.6 W	10.8 W	53 mA	90 °C	-40 ... +70 °C
LCO 40/200-1050/64 pD+ NF C PRE3	250 mA	25.6 V	38.0 V	9.5 W	12.8 W	61 mA	90 °C	-40 ... +70 °C
LCO 40/200-1050/64 pD+ NF C PRE3	300 mA	21.3 V	38.0 V	11.4 W	14.8 W	69 mA	90 °C	-40 ... +70 °C
LCO 40/200-1050/64 pD+ NF C PRE3	350 mA	18.3 V	38.0 V	13.3 W	16.8 W	77 mA	90 °C	-40 ... +70 °C
LCO 40/200-1050/64 pD+ NF C PRE3	400 mA	18.0 V	38.0 V	15.2 W	18.8 W	86 mA	90 °C	-40 ... +70 °C
LCO 40/200-1050/64 pD+ NF C PRE3	450 mA	18.0 V	38.0 V	17.1 W	20.8 W	94 mA	85 °C	-40 ... +65 °C
LCO 40/200-1050/64 pD+ NF C PRE3	500 mA	18.0 V	38.0 V	19.0 W	23.0 W	103 mA	85 °C	-40 ... +65 °C
LCO 40/200-1050/64 pD+ NF C PRE3	550 mA	18.0 V	38.0 V	20.9 W	24.9 W	111 mA	85 °C	-40 ... +65 °C
LCO 40/200-1050/64 pD+ NF C PRE3	600 mA	18.0 V	38.0 V	22.8 W	26.9 W	120 mA	85 °C	-40 ... +65 °C
LCO 40/200-1050/64 pD+ NF C PRE3	650 mA	18.0 V	38.0 V	24.7 W	28.9 W	129 mA	85 °C	-40 ... +65 °C
LCO 40/200-1050/64 pD+ NF C PRE3	700 mA	18.0 V	38.0 V	26.6 W	31.0 W	137 mA	85 °C	-40 ... +65 °C
LCO 40/200-1050/64 pD+ NF C PRE3	750 mA	18.0 V	38.0 V	28.5 W	33.1 W	147 mA	85 °C	-40 ... +65 °C

Type	Output current ^②	Min. output voltage	Max. output voltage	Max. output power	Typ. power consumption n (at 230 V, 50 Hz, full load)	Typ. current consumption n (at 230 V, 50 Hz, full load)	tc point max.	Ambient temperature ta
LCO 40/200-1050/64 pD+ NF C PRE3	800 mA	18.0 V	38.0 V	30.4 W	35.1 W	155 mA	85 °C	-40 ... +65 °C
LCO 40/200-1050/64 pD+ NF C PRE3	850 mA	18.0 V	38.0 V	32.3 W	37.3 W	165 mA	90 °C	-40 ... +65 °C
LCO 40/200-1050/64 pD+ NF C PRE3	900 mA	18.0 V	38.0 V	34.2 W	39.4 W	174 mA	90 °C	-40 ... +65 °C
LCO 40/200-1050/64 pD+ NF C PRE3	950 mA	18.0 V	38.0 V	36.1 W	41.5 W	183 mA	90 °C	-40 ... +65 °C
LCO 40/200-1050/64 pD+ NF C PRE3	1,000 mA	18.0 V	38.0 V	38.0 W	43.5 W	191 mA	90 °C	-40 ... +65 °C
LCO 40/200-1050/64 pD+ NF C PRE3	1,050 mA	18.0 V	38.0 V	39.9 W	45.7 W	201 mA	90 °C	-40 ... +65 °C

① Valid at 100 % dimming level.

② Depending on the selected output current.

③ Maximum of "perception and reaction" and "let go" values according to EN 60598-1.

④ Tolerance range ± 5 %.

⑤ Depending on the DALI traffic at the interface. DALI bus power supply deactivated. No-load on AUX power supply.

⑥ Output current is mean value.

⑦ L-N acc. to EN 61000-4-5. 2 Ohm, 1,2/50 µs, 8/20 µs.

1. Standards

EN 55015
 EN 61000-3-2
 EN 61000-3-3
 EN 61000-4-4
 EN 61000-4-5
 EN 61347-1
 EN 61347-2-13
 EN 62384
 EN 61547
 EN 62386-101 (DALI-2)
 EN 62386-102 (DALI-2)
 EN 62386-207 (DALI-2)
 According to EN 50172 for use in central battery systems
 According to EN 60598-2-22 suitable for emergency luminaire

1.1 Glow wire test

according to EN 61347-1 with increased temperature of 850 °C passed.

1.2 Light modulation

according to IEC 1789 device fulfils "no observable effect level".

2. Thermal details and lifetime

2.1 Expected lifetime

Expected lifetime HV

Type	Output current	ta	40 °C	45 °C	50 °C	55 °C	60 °C	65 °C	70 °C
LCO 40/200-1050/64 pD+ NF C PRE3	200 – 500 mA	tc	60 °C	65 °C	70 °C	75 °C	80 °C	85 °C	90 °C
		Lifetime	> 100,000 h	> 100,000 h	> 100,000 h	> 100,000 h	> 100,000 h	90,000 h	60,000 h
	>500 – 800 mA	tc	60 °C	65 °C	70 °C	75 °C	80 °C	85 °C	90 °C
		Lifetime	> 100,000 h	> 100,000 h	> 100,000 h	> 100,000 h	> 100,000 h	70,000 h	50,000 h
>800 – 1,050 mA	tc	60 °C	65 °C	70 °C	75 °C	80 °C	85 °C	90 °C	
	Lifetime	> 100,000 h	> 100,000 h	> 100,000 h	> 100,000 h	> 100,000 h	70,000 h	50,000 h	

Expected lifetime LV

Type	Output current	ta	40 °C	45 °C	50 °C	55 °C	60 °C	65 °C	70 °C
LCO 40/200-1050/64 pD+ NF C PRE3	200 – 400 mA	tc	60 °C	65 °C	70 °C	75 °C	80 °C	85 °C	90 °C
		Lifetime	> 100,000 h	> 100,000 h	> 100,000 h	> 100,000 h	> 100,000 h	90,000 h	60,000 h
	>400 – 800 mA	tc	60 °C	65 °C	70 °C	75 °C	80 °C	85 °C	–
		Lifetime	> 100,000 h	> 100,000 h	> 100,000 h	> 100,000 h	70,000 h	50,000 h	–
>800 – 1,050 mA	tc	65 °C	70 °C	75 °C	80 °C	85 °C	90 °C	–	
	Lifetime	> 100,000 h	> 100,000 h	> 100,000 h	80,000 h	60,000 h	50,000 h	–	

The LED driver is designed for a lifetime stated above under reference conditions and with a failure probability of less than 10 %.

The relation of tc to ta temperature depends also on the luminaire design.

If the measured tc temperature is approx. 5 K below tc max., ta temperature should be checked and eventually critical components (e.g. ELCAP) measured. Detailed information on request.

3. Installation / wiring

3.1 Circuit diagram

DALI with high voltage output (HV)

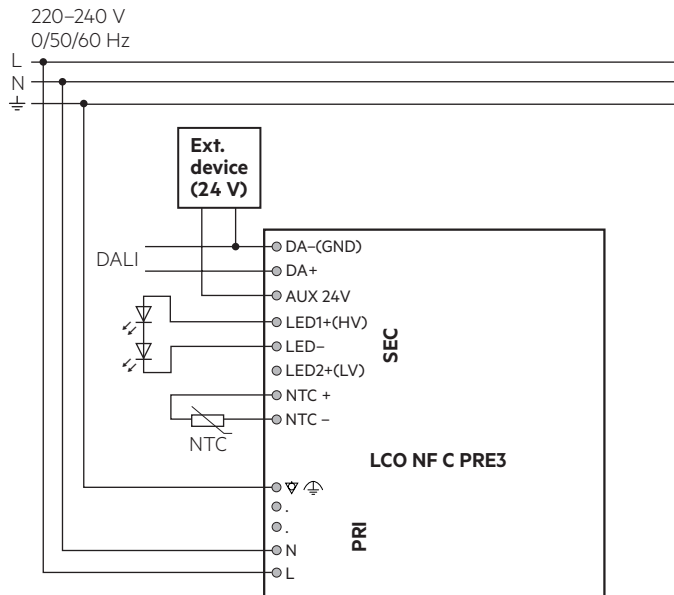

DALI with low voltage output (LV)

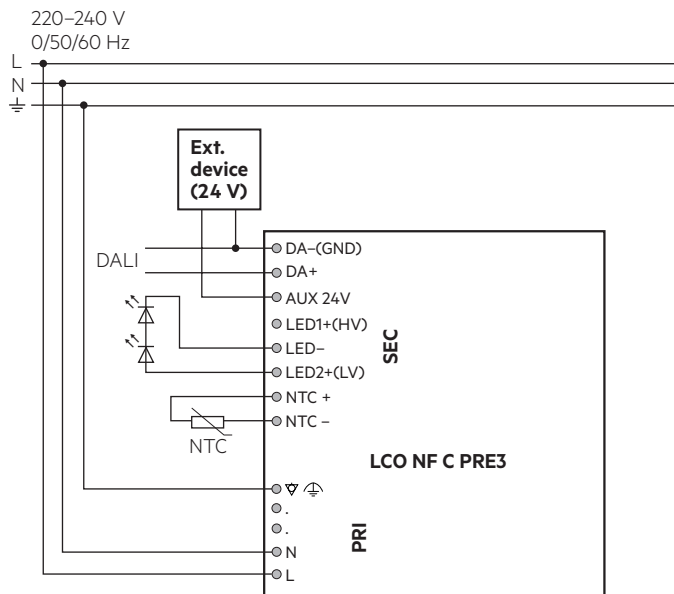

For wiring in dimming operation with ready2mains refer to the ready2mains Gateway data sheet.

3.2 Wiring type and cross section

Input side:

For wiring use solid wire from 0.2 – 1.5 mm².

Strip 8.5 – 9.5 mm of insulation from the cables to ensure perfect operation of terminals.

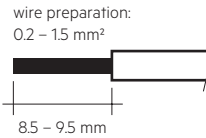

Output side:

For wiring use solid wire from 0.2 – 1.5 mm².

Strip 8.5 – 9.5 mm of insulation from the cables to ensure perfect operation of terminals.

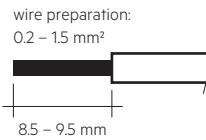

NTC terminal

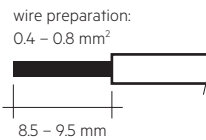

3.3 Wiring guidelines

- Run the secondary lines separately from the mains connections and lines to achieve good EMC performance.
- The max. secondary cable length (AUX, NTC, LED) is 2 m (4 m circuit).
- For good EMC performance, keep the LED wiring as short as possible.
- Secondary switching is not permitted.
- The LED driver has no inverse-polarity protection on the secondary side. Wrong polarity can damage LED modules with no inverse-polarity protection.
- Wrong wiring of the LED driver can lead to malfunction or irreparable damage.
- To avoid the damage of the Driver, the wiring must be protected against short circuits to earth (sharp edged metal parts, metal cable clips, louver, etc.).

3.4 Hot plug-in

Hot plug-in is not supported due to residual output voltage of > 0 V.

When connecting an LED load, restart the device to activate the LED output. This can be done via mains reset or via interface (DALI, ready2mains).

3.5 Earth connection

The earth connection is conducted as function earth (FE). There is no earth connection required for the functionality of the LED driver. Earth connection is recommended to improve following behaviour:

- Electromagnetic interferences (EMI)
- LED glowing at standby
- Transmission of mains transients to the LED output

4. Electrical values

4.1 Operating window

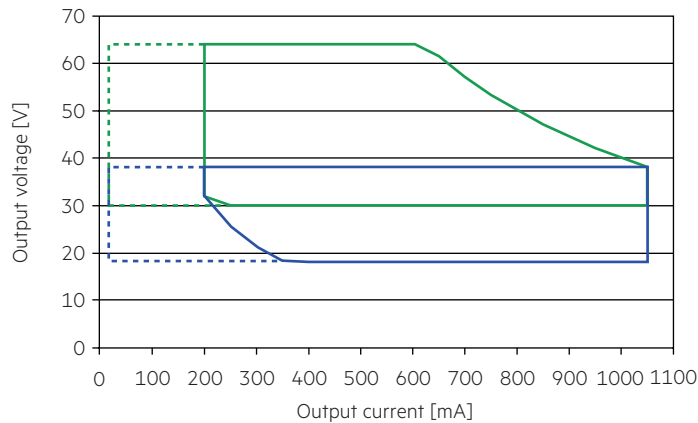

- Operating window 100 % (high output voltage)
- - - Operating window dimmed (high output voltage)
- Operating window 100 % (low output voltage)
- - - Operating window dimmed (low output voltage)

Make sure that the LED driver is operated within the given window under all operating conditions. Special attention needs to be paid at dimming and DC emergency operation as the forward voltage of the connected LED modules varies with the dimming level, due to the implemented amplitude dimming technology. Coming below the specified minimum output voltage of the LED driver may cause the device to shut-down. See chapter "6.5 Light level in DC operation" for more information.

4.2 Efficiency vs load (HV)

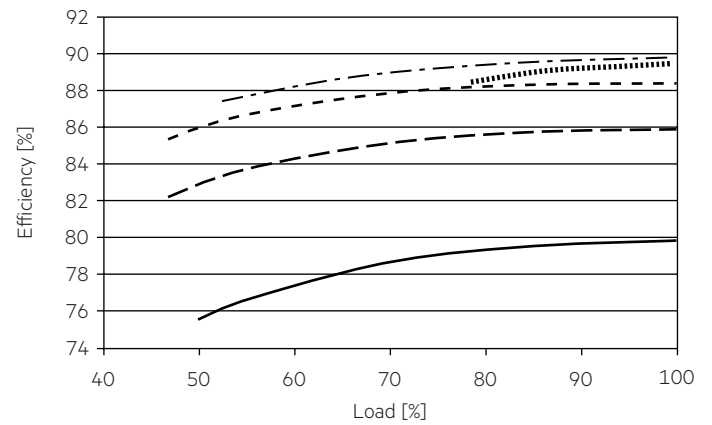

DALI bus power supply deactivated. No-load on AUX power supply.

4.3 Power factor vs load (HV)

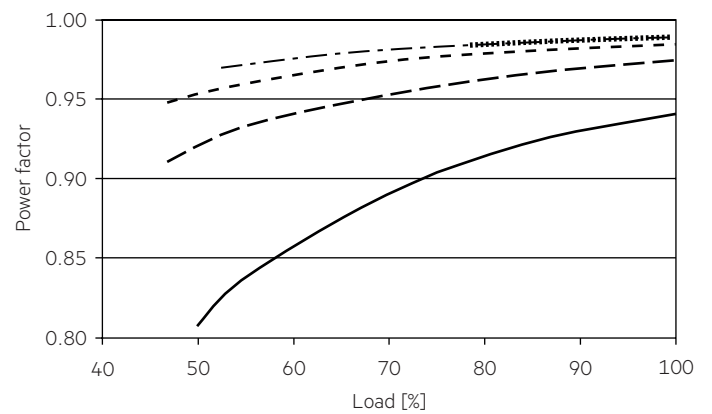

4.4 THD vs load (HV)

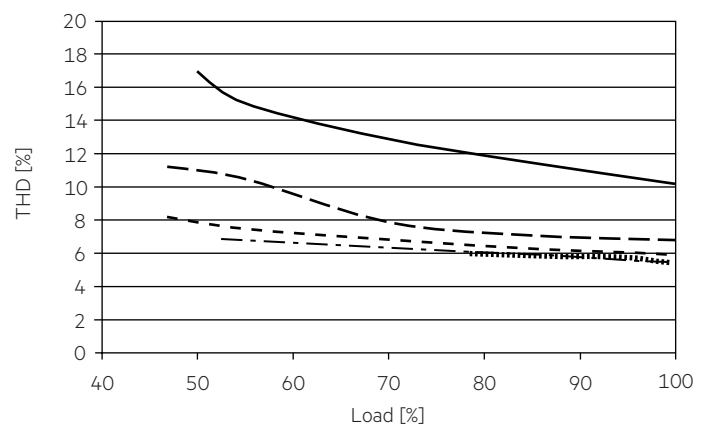

4.5 Efficiency vs load (LV)

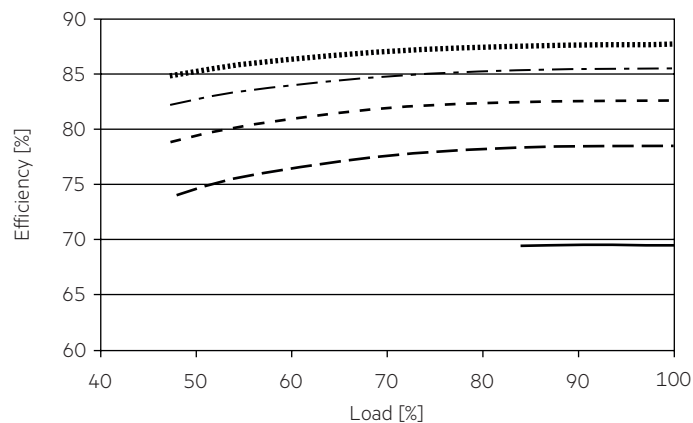

4.7 THD vs load (LV)

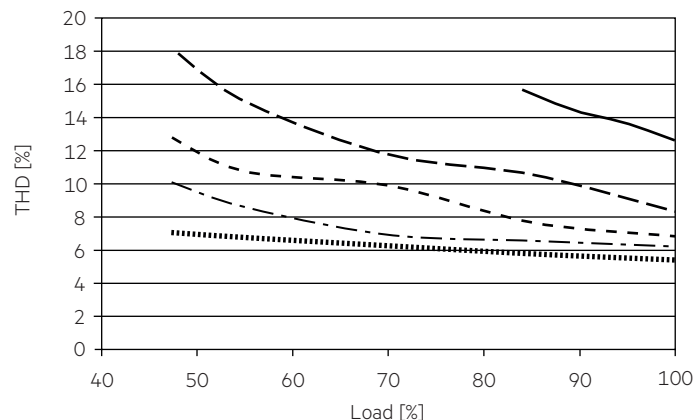

DALI bus power supply deactivated. No-load on AUX power supply.

4.6 Power factor vs load (LV)

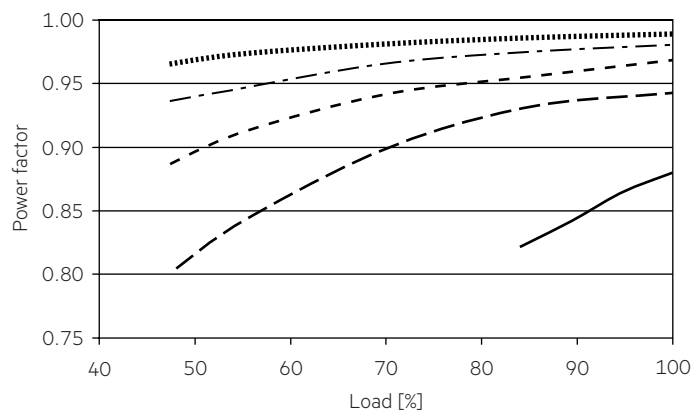

- 200 mA
- - - 350 mA
- - - 500 mA
- - - 700 mA
- 1050 mA

100 % load corresponds to the max. output power (full load) according to the table on page 3.

4.8 Maximum loading of automatic circuit breakers in relation to inrush current

Automatic circuit breaker type	C10	C13	C16	C20	B10	B13	B16	B20	Inrush current	
Installation Ø	1.5 mm ²	1.5 mm ²	2.5 mm ²	4 mm ²	1.5 mm ²	1.5 mm ²	2.5 mm ²	4 mm ²	I_{max}	time
LCO 40/200-1050/64 pD+ NF C PRE3	18	23	28	36	11	14	17	22	20.3 A	346 µs

These are max. values calculated out of inrush current! Please consider not to exceed the maximum rated continuous current of the circuit breaker. Calculation uses typical values from ABB series S200 as a reference. Actual values may differ due to used circuit breaker types and installation environment.

4.9 Harmonic distortion in the mains supply (at 230 V / 50 Hz and full load) in %

	THD	3.	5.	7.	9.	11.
LCO 40/200-1050/64 pD+ NF C PRE3	< 8	< 6	< 5	< 5	< 5	< 3

5. Software / Programming / Interfaces

5.1 Software / programming

With appropriate software and interface different functions can be activated and various parameters can be configured in the LED driver. The Driver supports the following software and interfaces:

Software / hardware for configuration:

- companionSUITE (deviceGENERATOR, deviceCONFIGURATOR, deviceANALYSER)
- masterCONFIGURATOR
- ready2mains Programmer

Interfaces for data transfer:

- NFC
- Control input DALI
- Control input ready2mains
- U6Me2

5.2 Nearfield communication (NFC)

The NFC Interface allows wireless communication with the LED driver. This interface offers the option to write configuration and to read configuration, errors and events with the companionSUITE. A correct communication between the LED driver and the NFC antenna can only be guaranteed if the antenna is placed directly on the Driver. Any material placed between the LED driver and the NFC antenna can cause a deterioration of the communication quality. After programming the device via NFC power up the device one time for one second till the deviceANALYSER can read out the parameters. We recommend the use of following NFC antenna:
www.tridonic.com/nfc-readers

NFC is complied with ISO/IEC 15963 standard.

5.3 Control input DALI

The control input is non-polar for digital control signals (DALI). The control signal is not SELV. The control cable has to be installed in accordance to the requirements of low voltage installations.

Digital control with:

- DALI signal: 16 bit

Dimming is realized by amplitude dimming.

5.4 Control input ready2mains (L, N)

The digital ready2mains protocol is modulated onto the mains signal which is wired to the mains terminal (L and N).

The configuration is done via the ready2mains Programmer, either directly at the Programmer itself or via a respective software tool. For details on the configuration via ready2mains see the technical information of the Programmer and its tools.

Following tools can be used:

- deviceCONFIGURATOR (companionSUITE)
- masterCONFIGURATOR
- ready2mains Programmer

5.5 U6Me2

Settings of chronoSTEP function could be done via switching mains commands. For detailed description for timings and intervals see product manual.

Key features:

- Auto-dimming with 8 sequences
- Every sequence can hold 8 parameter pairs
- Separate dim-level for each time parameter
- Various commands + parameter for extensions

6. Functions

⊙ companionSUITE:

DALI-USB, ready2mains Programmer, NFC

The companionSUITE with deviceGENERATOR, deviceCONFIGURATOR and deviceANALYSER is available via our WEB page:





















<https://www.tridonic.com/com/en/products/companionsuite.asp>

◇ masterCONFIGURATOR:

DALI-USB, ready2mains Programmer (in DALI mode)

The masterCONFIGURATOR is available via our WEB page:

<https://www.tridonic.com/com/en/software-masterconfigurator.asp>

Icon	Function	NFC	DALI-2	ready2mains	UGMe2
	OEM Identification	⊙	⊙ ◇	⊙	-
	OEM GTIN	⊙	⊙ ◇	⊙	-
	LED current	⊙	⊙ ◇	⊙	-
	Device operating mode	⊙	⊙ ◇	⊙	⊙
	chronoSTEP	⊙	⊙ ◇	-	⊙
	External temperature management (ETM + NTC)	⊙	⊙ ◇	⊙	-
	Enhanced constant light output (eCLO)	⊙	⊙ ◇	⊙	-
	DC level	⊙	⊙ ◇	⊙	-
	Enhanced power on level (ePOL)	⊙	⊙ ◇	⊙	-
	Intelligent temperature guard (ITG)	⊙	⊙ ◇	⊙	-
	DALI default parameters	⊙	⊙ ◇	-	-
	Scenes and groups	⊙	⊙ ◇	-	-
	Customer memory bank	⊙	⊙ -	-	-
	Energy reports	⊙	⊙ -	-	-
	Diagnostic and monitoring	⊙	⊙ -	-	-
	pDALI integrated DALI bus voltage	⊙	⊙ -	-	-
	sensorMODE	⊙	⊙ ◇	-	-
	Power-up fading	⊙	⊙ ◇	-	-
	Dimming curve	⊙	⊙ ◇	-	-
	Last Gasp	⊙	⊙ -	-	-

6.1 LED current



The LED output current must be adapted to the connected LED module. The value is limited by the current range of the respective device.

The priority for current adjustment methods is NFC / DALI (highest priority) and ready2mains (lowest priority).

6.2 chronoSTEP (Virtual Midnight)



In the outdoor lighting and street lighting sector it often makes sense to dim the lighting level during night hours in order to save energy.

The chronoSTEP function is a tool that makes this easy to do.

The device automatically measures the switch-on and switch-off times of the lighting installation over the past three days.

The switch-on and switch-off times are typically the times at which the sun sets and rises. The midpoint of these two reference points is the time referred to as Virtual Midnight. The overall time interval between switch-on and switch-off points is called On Time.

Notice

When calculating the On Time, only values between 4 and 24 hours are counted. Values less than 4 hours could indicate a power failure and are therefore not saved. For settings longer than 24 hours, 24 hours is saved as the maximum possible value.

6.3 External temperature management (ETM + NTC)



ETM protects the LED module against thermal overstress.

An external temperature sensor (NTC) detects the LED module temperature and the LED driver will limit the output current according to this temperature:

If the temperature is between the limits T1 (normal condition) and T2 (overload), the LED output current will be decreased.

If the temperature exceeds the limit T3 (critical temperature), the device will switch to the shutdown level.

The shutdown level will be active until the module temperature decreases below T1 or until the LED driver is restarted (switch off or mains reset).



The LED module's temperature is only measured if the output is active (lamp is on).

The allowed NTC resistor value is between 0 to 2 M Ω .

By default there are three predefined values that can be set via programming software, up to five individual values can be added.

6.4 Enhanced Constant Light Output (eCLO)



With this function the light output of the LED module can be kept equal over the lifetime.

The light output of an LED module reduces over the course of its lifetime.

The Constant Light Output (eCLO) function compensates for this natural decline by constantly increasing the output current of the LED driver throughout its lifetime.

Enhanced eCLO shall be achieved by limitation of the LED current at the commissioning of the LED driver and providing a linear interpolation of the current over the time, depending on the data points given by the user. The user has to insert up to eight pairs of data (time, level). The output curve is the result of connecting the user data points linear. Detailed description for eCLO see product manual.

6.5 Light level in DC operation



In emergency light systems with a central battery supply the DC recognition function uses the input voltage to detect if emergency mode is present.

The LED driver then automatically switches to DC mode and dims the light to the defined DC level.

Without DC recognition different and more complex solutions would have to be applied in order to detect emergency mode.

DC recognition is integrated in the device as standard.

No additional commissioning is necessary for activation.



This is a safety-relevant parameter.

The setting is relevant for the dimensioning of the central battery system.

The LED driver is designed to operate on DC voltage and pulsed DC voltage. For a reliable operation, make sure that also in DC emergency operation the LED driver is run within the specified conditions as stated in chapter "4.1 operating window".

Light output level in DC operation: programmable 1 – 100 %
(factory default = 15 %, EOF_i = 0.13).

The voltage-dependent input current of Driver incl. LED module is depending on the used load.

The voltage-dependent no-load current of Driver (without or defect LED module, DALI bus power supply deactivated and no-load on AUX power supply) is for:

AC: < 17 mA

DC: < 4 mA

In DC operation dimming mode can be activated.

If Dimming on DC is activated the requirements of the DC recognition function are ignored.

Even if DC is detected, the LED driver continues to behave as in AC mode

- The present dimming level is retained
- An emergency light level defined for the DC recognition function (DC level) is ignored
- Control signals via DALI continue to be executed

If Dimming on DC is activated then emergency mode is not recognised. The device no longer automatically switches to the emergency light level.

6.6 Intelligent Temperature Guard (ITG)



The intelligent temperature guard protects the LED driver from thermal overheating by reducing the output power or switching off in case of operation above the thermal limits of the luminaire or ballast. Depending on the luminaire design, the ITG operates at about 5 to 10 °C above t_c temperature.

If temperature threshold values are exceeded, the LED output current is limited.

These limits can be adjusted using the programming software.

Even the current ITG temperature in the device can be read out. With this function, the sensitivity of the temperature control can be adjusted.

6.7 Power-up fading



The power-up function offers the opportunity to modify the on behavior. The time for fading on can be adjusted in a range of 0.2 to 16 seconds. According to this value, the device dims either from 0 % up to the power-on level.

By factory default no fading time is set (= 0 seconds).

6.8 Memory bank 1 extension



This function provides an extension to memory bank 1 to enable asset management functionality. Several internal values from the driver could be read out from this memory bank.

For example luminaire year, week and description.

Also power levels, AC mains voltages and light output can be read out.

6.9 Energy reporting



This function provides the information related to energy reporting accessible through memory banks in this driver.

Several functions and values could be read out to gain access in Content management systems.

Report and values for Active power, Active Energy and many more can be read out.

6.10 Diagnostics & Maintenance



This function provides the information related to diagnostics and maintenance information accessible through memory banks.

Several functions and values could be read out to gain access in Content management systems.

Report and values for failure behaviour, driver conditions and malfunctions trigger points can be read out.

6.11 Integrated DALI bus power supply



This function complies to DiiA specification DALI Part 250 - Integrated bus power supply.

The output power of the integrated DALI Bus Power Supply (pDALI) has an output current of 50 mA (max. 62.5 mA).

It is activated by factory default.

Sensors and also external drivers could be directly connected to this power supply. The DALI power supply could be deactivated via software.



Power supplies can be combined up to 250 mA max in total. This maximum must not exceed. The polarity has to be considered.

If the DALI power supply is activated, the driver must not be integrated into an existing, already with 250 mA powered DALI network.

6.12 AUX power supply



An auxiliary (AUX) supply provides 24 V DC to power e.g. a controller, an occupancy sensor, a photo sensor or other device. It eliminates the need of an AC/DC supply and the associated need of surge suppression and an EMI filter in such devices.

AUX supply specification:

Average power of 3 W.

Average output voltage of 24 V ± 10 %

Maximum voltage does not exceed 30 V under any load condition including open circuit.

Start-up time: 90 % of the nominal specified voltage level within 600 ms after applying mains power.

Start-up: After power-on, the load must limit the current consumption at the AUX terminals to at most 160 mA until the specified voltage is reached.

6.13 sensorMODE



The sensorMODE combines the features chronoSTEP and corridorFUNCTION and adds the possibility to control them with a DALI input device directly connected to the LED driver.

There are different control modes supported by the sensorMODE function:

- Ambient light control
- Motion control
- Ambient light with motion control
- Mains with motion control

6.14 Last Gasp



This function enables the connected application controller to identify a mains power supply loss situation and perform "last second" operations before shutdown, e.g.:

- Send out a message (e.g. wireless to host system)
- Store data

If mains shut down the driver supports:

- Signaling the mains power supply outage by pulling the DALI-2 internally bus power supply signal to low
- Providing the required energy budget via 24V AUX power supply (≥ 300 mJ)

Per default the function is deactivated and can be activated via DALI-2 or NFC over the companionSUITE.

This function is only available in AC mains operation.

7. Protective features

7.1 Overtemperature protection

The LED driver is protected against temporary thermal overheating. If the temperature limit is exceeded the output current of the LED module(s) is reduced. The temperature protection is activated above $t_{c\ max}$.

The activation temperature differs depending on the LED load.

On DC operation this function is deactivated to fulfill emergency requirements.

7.2 Short-circuit behaviour

In case of a short-circuit at the LED output the LED output is switched off. After restart of the LED driver the output will be activated again. The restart can either be done via mains reset or via interface (DALI, ready2mains).

7.3 No-load operation

The LED driver will not be damaged in no-load operation. The output will be deactivated and is therefore free of voltage. If a LED load is connected, the device has to be restarted before the output will be activated again.

7.4 Overload protection

If the maximum load is exceeded by a defined internal limit, the LED driver turns off the LED output. After restart of the LED driver the output will be activated again.

The restart can either be done via mains reset or via interface (DALI, ready2mains).

7.5 IVG+ – Intelligent Voltage Guard Plus



In some cases mains voltage is not stabilized and has some voltage peaks which are lower or higher than the nominal voltage range.

Between 192 V and 80 V input voltage, the LED driver operates in under-voltage mode and dims the secondary side linearly down to 10 %.

Below 80 V input voltage, the LED driver shuts down, restarts at 90 V (without a reset) and dims linearly up back to 100 %. Above 280 V input voltage, the LED driver shuts down. If input voltage drops below 270 V, the LED driver restarts (without a reset).

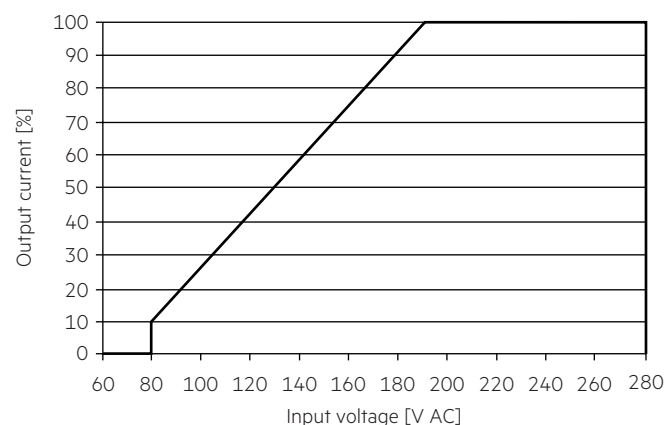

7.6 Insulation between terminals

Insulation	Mains	FE	NTC / LED	AUX / DALI
Mains	–	double	double	double
FE	double	–	basic	basic
NTC / LED	double	basic	–	basic
AUX / DALI	double	basic	basic	–

basic ... represents basic insulation.

double ... represents double or reinforced insulation.

7.7 OEM key

OEM key memory banks could be protected from unauthorized access with special master key.

8. Miscellaneous

8.1 Insulation and electric strength testing of luminaires

Electronic devices can be damaged by high voltage. This has to be considered during the routine testing of the luminaires in production.

According to IEC 60598-1 Annex Q (informative only!) or ENEC 303-Annex A, each luminaire should be submitted to an insulation test with 550 V_{DC} for 1 second. This test voltage should be connected between the interconnected phase and neutral terminals and the earth terminal. The insulation resistance must be at least 2 MΩ.

As an alternative, IEC 60598-1 Annex Q describes a test of the electrical strength with 1550 V_{AC} (or 1.414 x 1550 V_{DC}). To avoid damage to the electronic devices this test must not be conducted.

The equipotential terminal is used to connect the heat sink and the LED driver to reduce transients.

8.2 Conditions of storage and use

Humidity: 5% up to max. 90%,
not condensed
(max. 56 days/year at 90%)

Storage temperature: -40 °C up to max. +80 °C

The devices have to be acclimatised to the specified temperature range (ta) before they can be operated.

The LED driver is declared as inbuilt LED controlgear, meaning it is intended to be used within a luminaire enclosure.

If the product is used outside a luminaire, the installation must provide suitable protection for people and environment (e.g. in illuminated ceilings).

8.3 Maximum number of switching cycles

All LED driver are tested with 50,000 switching cycles.
The actually achieved number of switching cycles is significantly higher.

8.4 Additional information

Additional technical information at www.tridonic.com → Technical Data

Lifetime declarations are informative and represent no warranty claim.
No warranty if device was opened.